

## Cougar Fan Coil Unit

### Installation, Operation & Maintenance Instructions

Dunham-Bush Ltd, Downley Road, Havant, Hants PO9 2JD

Tel: 023 9247 7700

UK:www.dunham-bush.co.uk

Email: info@dunham-bush.co.uk

Global:www.dunham-bush.com



Document Ref:

127-000-001-B

June 2018

**NOTE: PLEASE LEAVE COPIES OF THESE INSTRUCTIONS AND ANY WIRING DIAGRAMS AND OTHER RELEVANT LITERATURE WITH THE END USER.**

#### INTRODUCTION

This booklet provides guidance to identify, handle, install and commission Dunham-Bush Cougar fan coil units as well as guidance for operation and maintenance.

**These instructions are to be read in conjunction with the wiring diagram supplied with the unit.**

The instructions apply to units from the standard range only. Please study the instructions carefully before commencing any installation work.

#### IDENTIFICATION

The fan coil unit serial number, description and figure number (size) are displayed on a label found on the unit discharge plenum. If specified, a stencil reference may also be marked on the discharge plenum for on-site identification.

#### DESCRIPTION

Dunham-Bush Cougar fan coil unit comprises a self-finished galvanised sheet steel casing with multiple access panels to each part of the fan coil unit, including fans, motors, air filter, dual purpose heating/cooling coil, electrical connections box and discharge plenum. Fan coil units are designed for continuously variable fan speed, with fan speed set by a 0-10VDC signal.

#### STANDARD RANGE MODELS & SIZES

Cougar is a horizontal basic chassis fan coil unit, available in seven sizes, figs 1 to 7 inclusive

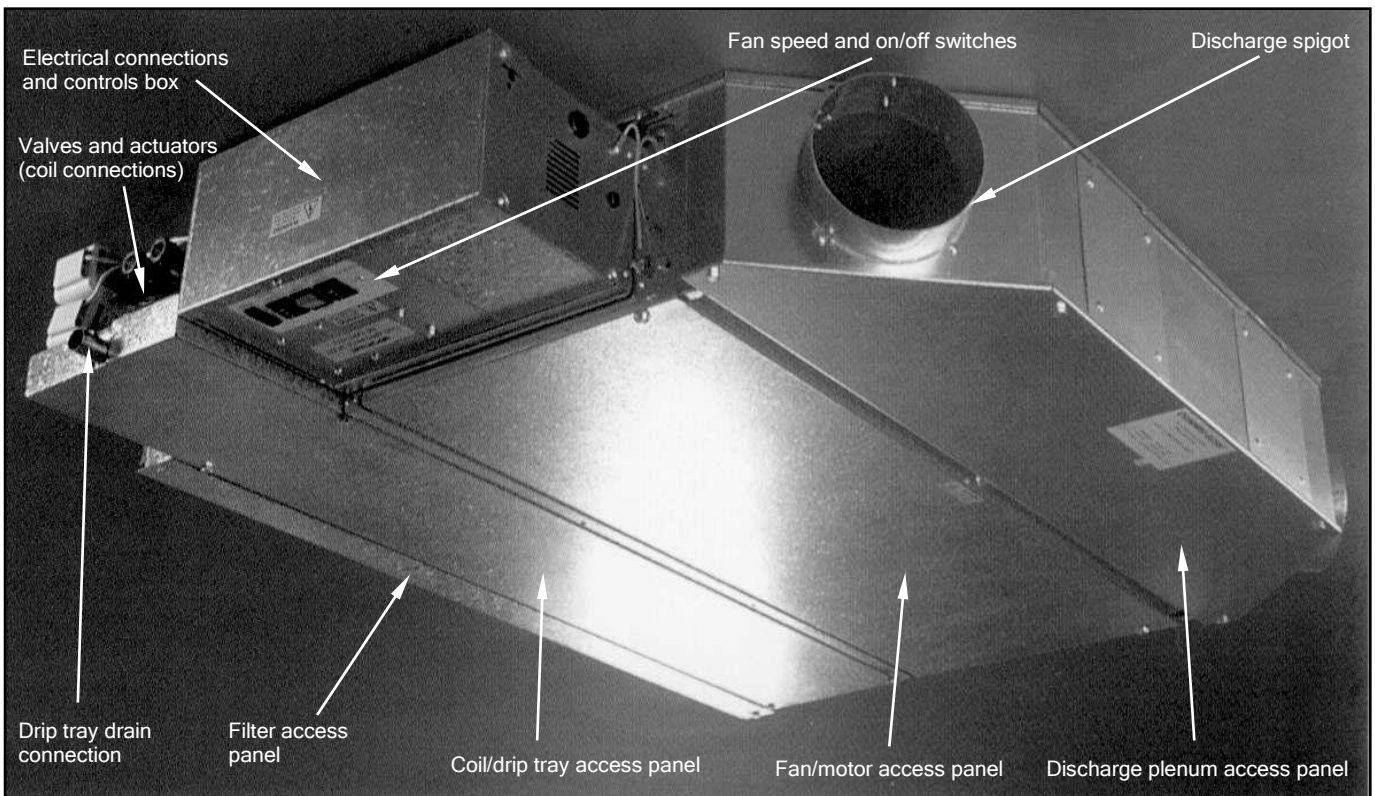

Diagram 1 - Cougar Fig 3 LH connections with octagonal discharge plenum

Size	Dim 'A'	Dim 'B'	No. of spigots
1	675	641.2	3
2	1075	1041.2	5
3	1075	1041.2	5
4	1475	1441.2	7
5	1475	1441.2	7
6	1875	1841.2	8
7	1875	1841.2	8

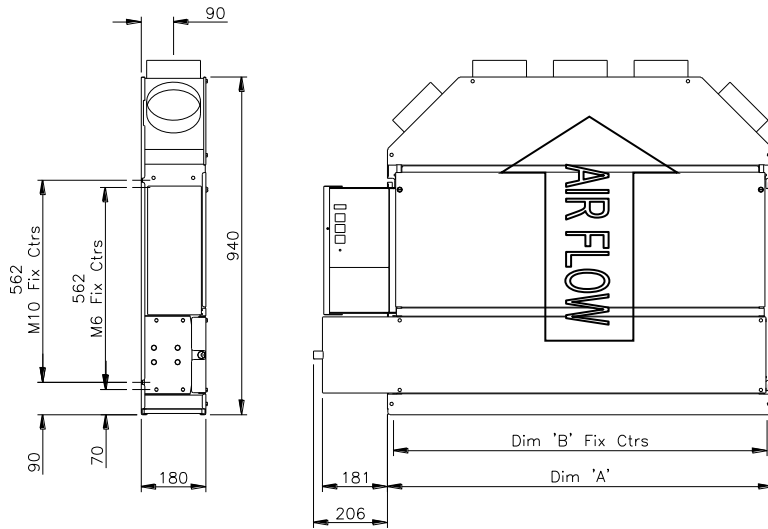

Diagram 2: Range of standard sizes with octagonal discharge plenum

## ACCESSORIES

### *Standard controls*

Dunham-Bush Cougar fan coil units are available with accessories for fitted stand alone or remote control. These include fitted or remote setpoint adjusters, remote room air sensors and remote fan speed controllers. Refer to the wiring diagram included with the fan coil unit for details on installation and wiring of remote controls.

### *Discharge Configuration*

The standard configuration is for an octagonal discharge plenum with up to eight spigots (depending on size/figure number). Spigots can be fitted up to Ø160mm, and can be removed and repositioned to suit duct connections on site. Spigots that are not required have an acoustically lined blanking plate fixed with self-tapping screws.

## CONSTRUCTION

### *Delivery*

The purchaser is responsible for off-loading, and must examine the fan coil units promptly upon receipt. Any claims for damage will only be accepted if, at the time of delivery, the consignment note is endorsed with the details and counter-signed by the transport driver. Each fan coil unit is marked to show the model, figure number, serial number and stencil reference if specified.

### *Handling and Storage*

Fan coil units are individually packed, and two/three persons can usually handle the heaviest unit. When a significant quantity of fan coils is delivered, they may be palletised and shrink-wrapped, so a fork-lift or similar will be required for lifting. The fan coil unit must not be dropped or suffer impact in any circumstances and should never be lifted or handled by their coil connections.

Fan coil units should be stored in clean, dry conditions. Any packaging should not be removed until the fan coil unit is required for installation. Packaging should only be removed if damage is suspected at the time of delivery.

**▲WARNING: Cougar fan coil units are designed with minimal sharp edges on the chassis. Some internal components on the fan coil may have sharp edges. Care must be taken when handling the product; protective gloves should be worn.**

FIGURE	1	2	3	4	5	6	7
Dry mass of basic unit with discharge spigot plenum only (kg)	43	60	65	81	86	103	108

Table 1: Approximate masses of Cougar fan coil units

## INSTALLATION

### General

Before removing any packaging, check the identity of the fan coil unit against the stencil reference marked on the access panel. Packaging should be retained to protect the fan coil unit from damage by other works after installation.

### Fitting

1. Prepare drop rods to accept the fan coil. M6, M8 or M10 drop rods are recommended, with appropriate washers. Refer to diagram 2 for positions of fixings.
2. Suspend the fan coil unit and ensure it is level in both directions. Use a spirit level on the casing. (The drip tray is graded internally to ensure drainage of condensate).
3. Connect ductwork to the fan coil unit. Flexible duct connections are recommended where sheet metal ductwork is used. Do not suspend any ductwork from the fan coil unit alone. Refer to diagram 4 for spigot positions.
4. Connect pipework as shown in Diagram 5.
5. Connect a suitable drain to the drip tray.
6. Connect electrical supply and control accessories as shown in wiring diagrams enclosed with the fan coil unit.
7. After filling the hot and chilled water systems, check for leaks (refer to Commissioning).
8. Ensure condensate pump is installed in accordance with the manufacturer's requirements and see Diagrams 3a and 3b below.

### Pipework Connections

1. The coil is a dual-purpose coil with OD15mm copper tube tails at 40mm centres between flow and return connections. Always observe the correct direction of flow. (see Diagram 5)
2. Local isolating and regulating valves are recommended, as well as strainers to filter out foreign matter in the water.
3. The installer must provide any fittings to connect pipework to fitted 2 or 4 port valves.
4. The drip tray has an OD22mm tube connection, suitable for a compression fitting or similar, to be supplied by the installer.

### Electrical connections and controls

1. The electrical connections box is located on the side of the fan coil unit, and incorporates a hinged access door, fastened with a self-tapping screw.
2. Connect a 230V/1ph/50Hz supply to the flying lead fitted to the electrical connections box.
3. Fit any remote accessories in their appropriate locations and connect terminal block inside the electrical connections box.  
**Refer to the wiring diagram enclosed with the fan coil unit for specific wiring details.**
4. All wiring should comply with IEE regulations (BS 7671) and local bye-laws.

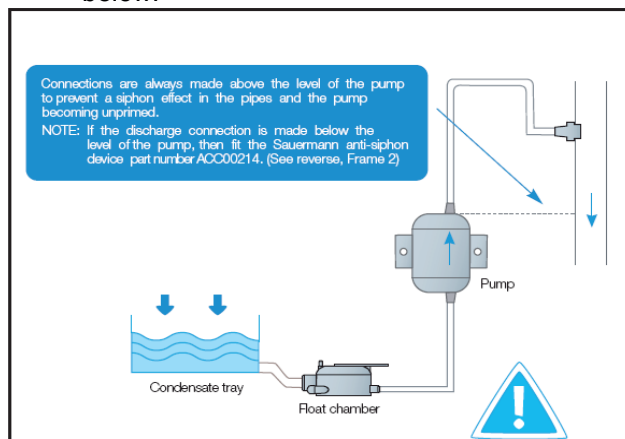

Diagram 3a

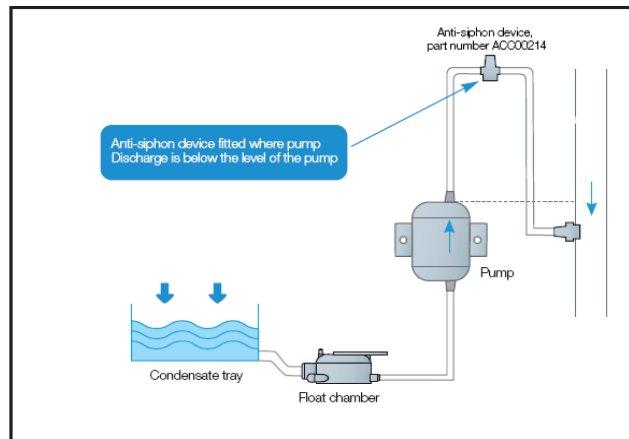

Diagram 3b

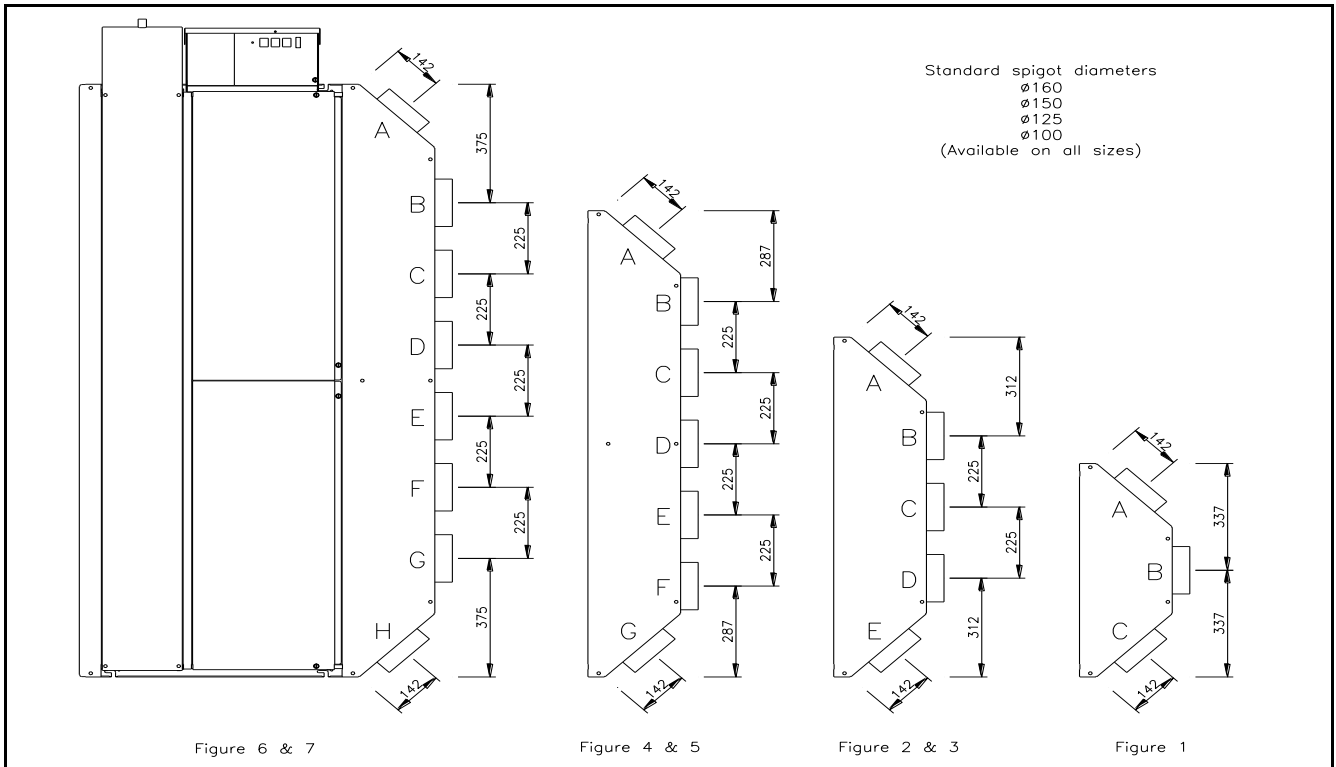

Diagram 4: Standard spigot sizes and positions

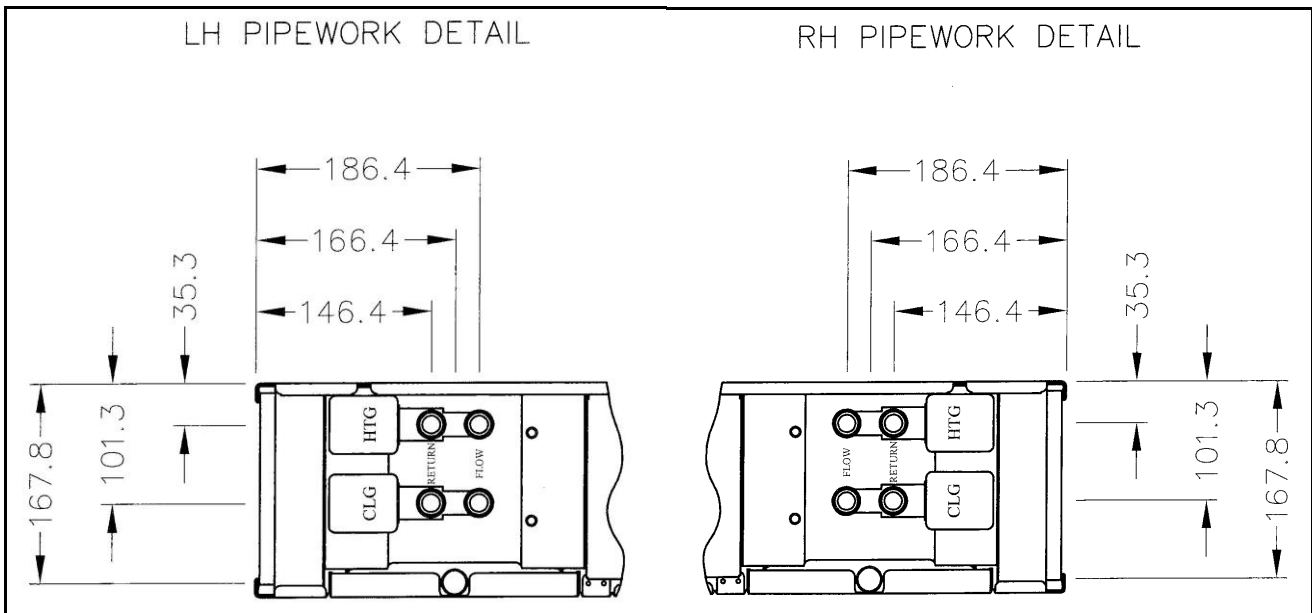

Diagram 5: Pipework connections, as viewed on header/connection end of coil

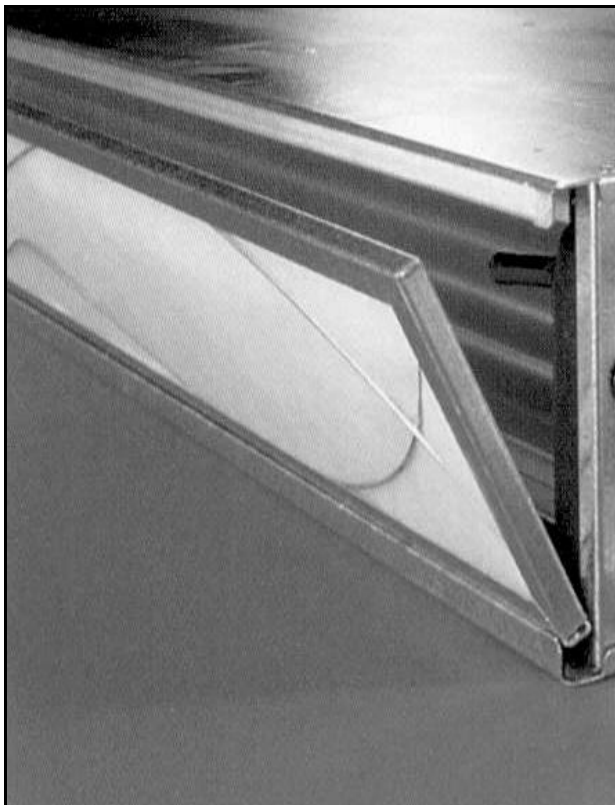

Diagram 6: Inlet and filter

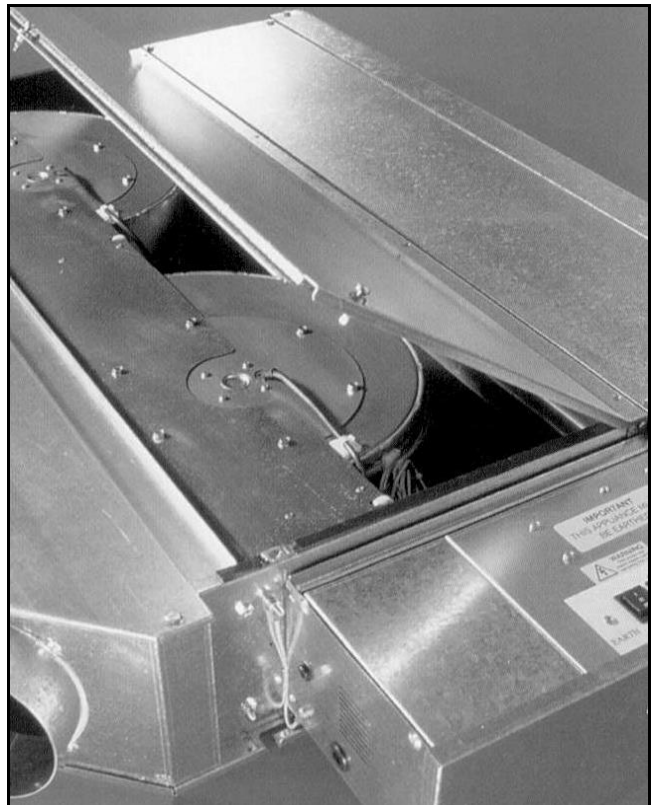

Diagram 7: Fan access panel

## COMMISSIONING

1. Ensure that the fan coil unit is clean, and the filter especially is clean and free from dust. Check the fastness of all access panels and ductwork connections.
2. Check that all electrical connections are correct and comply with BS7671 and local bye-laws. **Refer to the wiring diagram supplied with the fan coil unit**
3. Check the coil connections and drip tray connections for leaks. Refer to Table 3 for coil test and working pressures.
4. Purge air from both heating and cooling sections of the coil using the manual air vents fitted.
5. Balance the water flow rate through both hot and chilled water systems following accepted practice to achieve the specified flow rates.
6. On AC motor units, there are two fan speed switches - one to give three main speeds, and the other to provide a 'fine-adjust' to each speed. Set the switches to the specified design settings, as highlighted on the label fixed to the plenum access panel.  
(Refer to diagram 8 for fan switch settings)
7. On EC motor units, adjust potentiometer to ensure air volume to design specification. If using a BMS controller with a 0-10V output, adjust the fan via the remote interface to ensure air volume and external static resistance are both to design specification.
8. If fitted, set any remote switches and/or controls to the specified settings.
9. Check the operation of controls in accordance with control manufacturer's instructions.
10. Check the operation of any remote fan speed or remote thermal controls.
11. If supplied/fitted, check the operation of the condensate pump by pouring a small quantity of water into the drip tray; ensure the pump clears any water and operates any alarms etc.
12. Leave this document and the wiring diagrams with the end user.

**For further information on any fan coil unit - contact Dunham-Bush, quoting the serial number on the label on the access panel.**

Size	Cooling coil valve Kv	Heating coil valve Kv
Figure 1	1.0	0.6
Figure 2 & 3	1.0	0.6
Figure 4 & 5	1.0	0.6
Figure 6 & 7	1.0	0.6

Table 2 - 4 port valves; recommended Kv values to match coils

Coil Section	Maximum test pressure	Recommended working pressure
Cooling	20 bar gauge	7 bar gauge
Heating	20 bar gauge	7 bar gauge

Table 3 - Maximum test and working pressures

**WARNING**  
 Air vents should not be operated during pressure tests. Recommended working pressure is limited to 7 bar gauge to ensure safe operation of manual air vents.

Size	Cooling section content (l)	Heating section content (l)
Figure 1	1.70	0.20
Figure 2 & 3	2.55	0.28
Figure 4 & 5	3.68	0.40
Figure 6 & 7	4.53	0.51

Table 4 - Water content of cooling and heating sections of coil

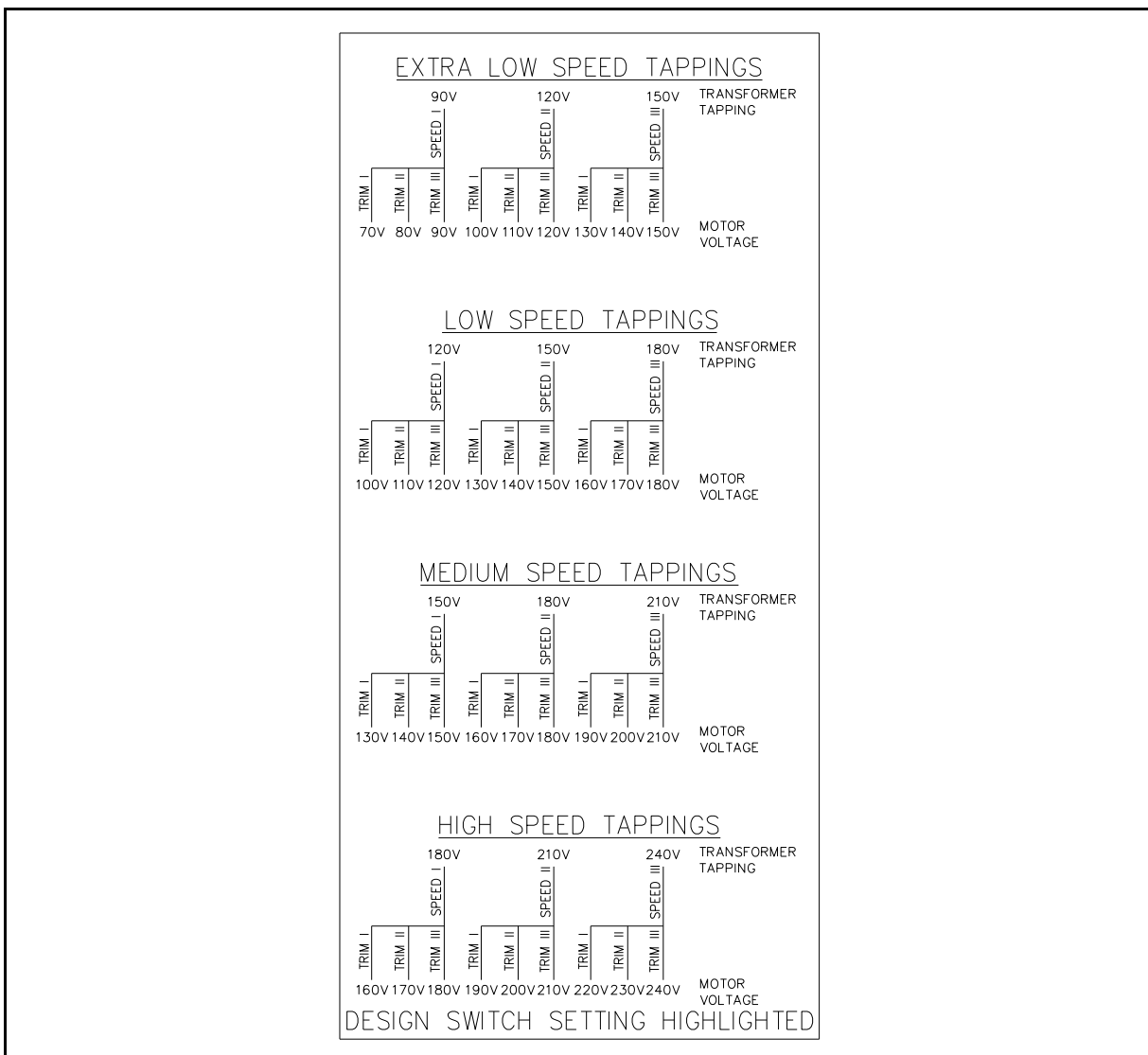

Diagram 8: Fan switch speed settings; also shown as label affixed to fan coil unit (AC motor units only)

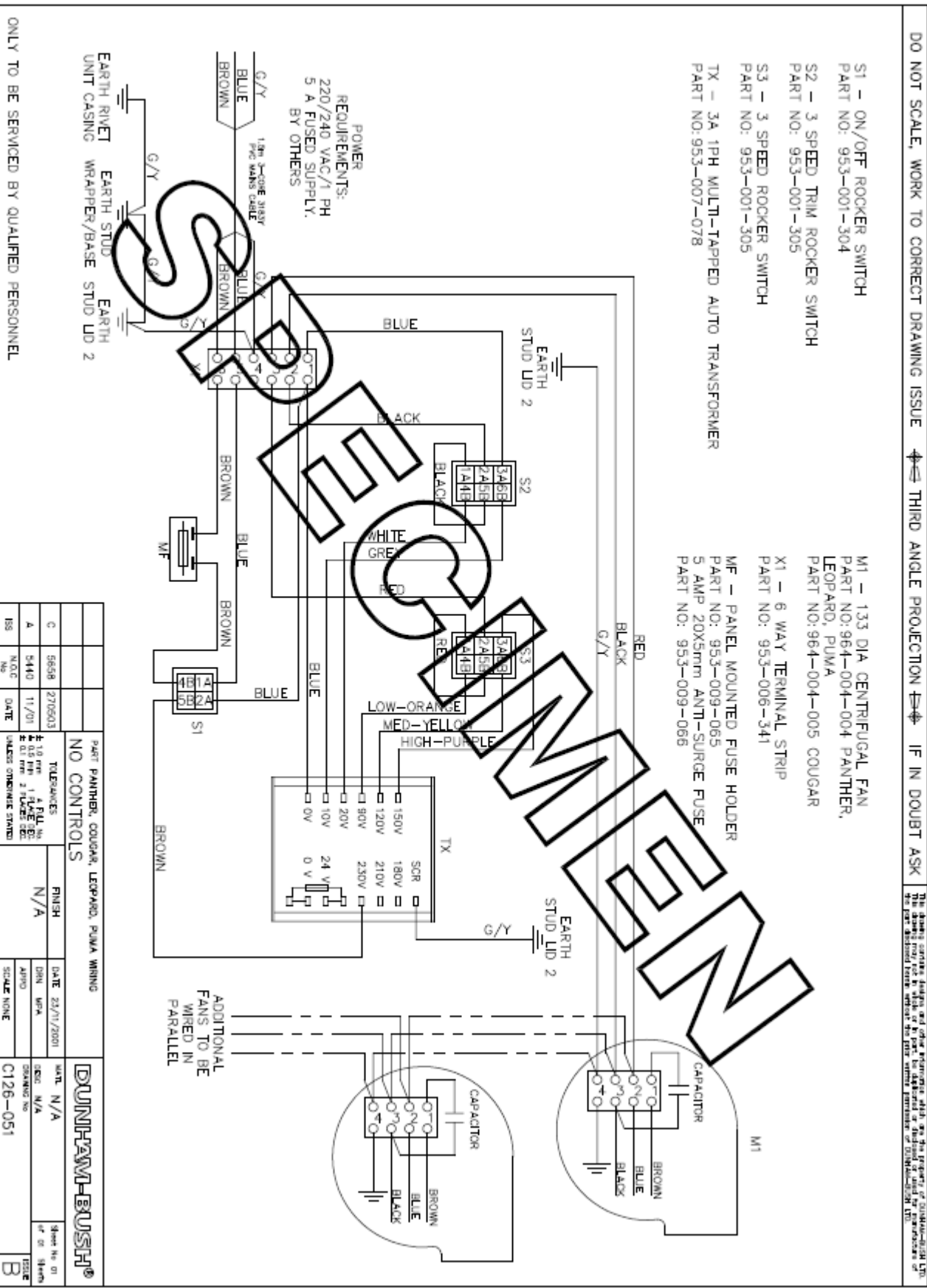

Diagram 9: Typical wiring diagram - Basic AC motor speed Control - Refer to wiring diagram supplied with unit.

**NOTES:-**

1. REFER TO W.O. FOR MOTOR HARNESS DETAILS.
2. DISCONNECT SUPPLY TO HARMONIC FILTER PRIOR TO FLASH TEST WITHIN PATS TEST RECONNECT FOR RUN TESTS.

— WIRING BY DUNHAM-BUSH  
 - - - - WIRING BY OTHERS

**LEGEND:-**

- S1 — ON/OFF ROCKER SWITCH
- MF — PANEL MOUNTED FUSE
- 5 AMP 20X5mm ANTI-SURGE FUSE
- X1 — 5 WAY TERMINAL STRIP
- M1 — CENTRIFUGAL FAN
- 964-004-015
- F1 — FILTER HARMONIC
- 953-041-003
- SC1 — SPEED CONTROLLER
- 903-003-068

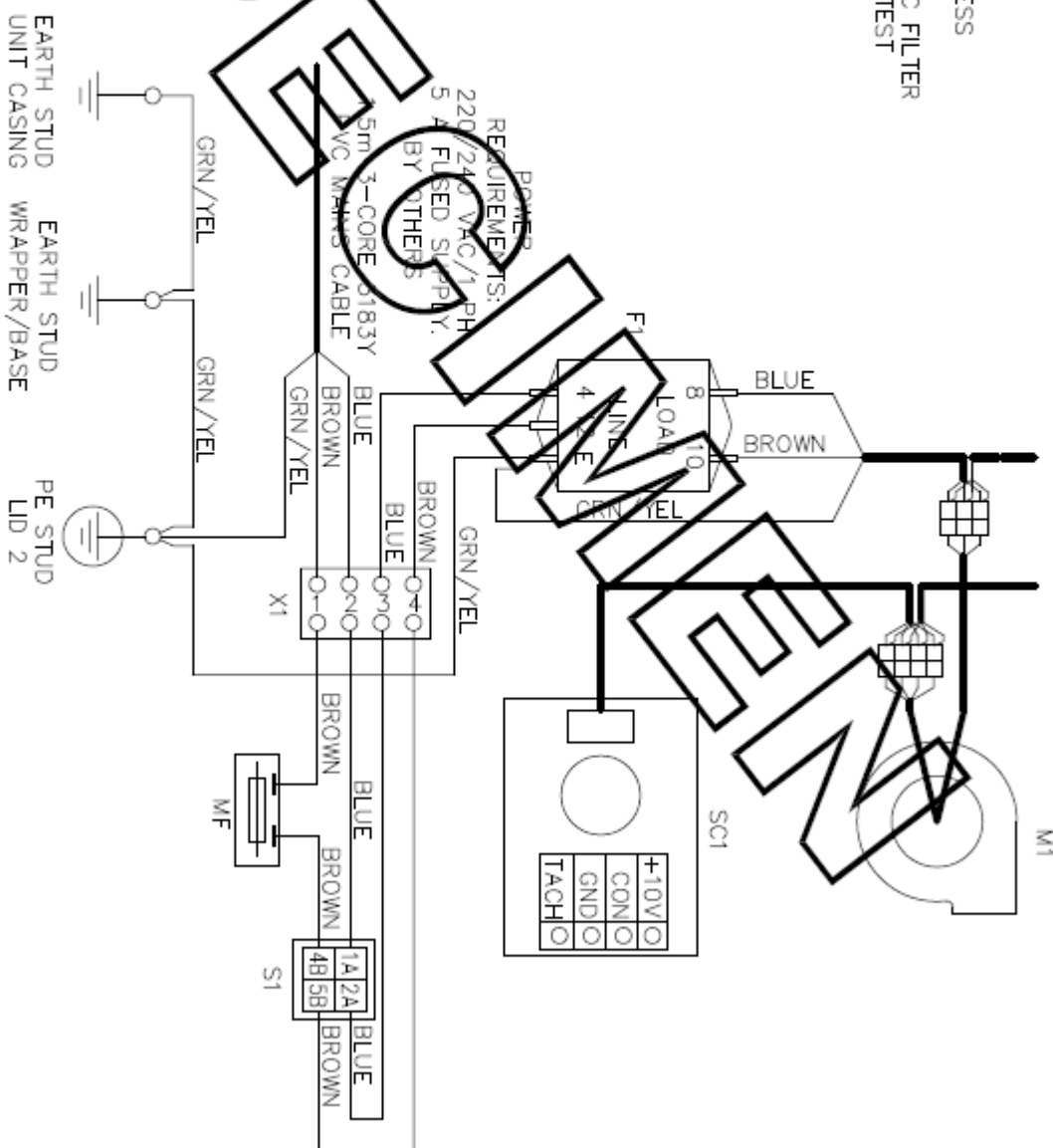

PART: PANTHER, COUGAR, LEOPARD, PUMA WIRING			DUNHAM-BUSH®	
BASIC EC UNIT			WTL	
TOLERANCES			DRAWING No	
± 0.10 mm			1 of 1 Sheet	
± 0.05 mm			ISSUE	
± 0.01 mm			DATE	
2 PLACE DEC.			SCALE NONE	
3 PLACE DEC.			C226-001	
FINISH			DATE 20.6.07	
ISS			DATE 11.10.06	
NO.			DATE	
NO.			DATE	
NO.			DATE	
NO.			DATE	
NO.			DATE	
NO.			DATE	

Diagram 10: Typical wiring diagram - Basic EC motor speed Control - Refer to wiring diagram supplied with unit



## OPERATION

Cougar fan coils provide cooling and heating of air when used in conjunction with chilled water and/or low temperature hot water systems. They are designed for mounting in a ceiling or roof void, connected to ductwork.

When running, the fan draws air from the room and the primary air supply, through an inlet filter and over the finned tubes of a heating/cooling coil. The air is then discharged through spigots, along ductwork and through grilles or diffusers to the room space.

Alternative options include chilled water cooling only, and intake through ductwork and spigots.

Fans normally run continuously, with an automatic control system varying the flow rates of chilled water and hot water through the coil (waterside control), thus varying the cooling and heating outputs. Depending upon the particular type of controls fitted, user control is provided by 0-10VDC signal and/or temperature control.

## CONTROLS

Cougar fan coil units are fitted with a waterside control system, which typically comprises the following elements: -

- Fitted fan on/off switch
- Fan speed change switches (AC motor units)
- Fan speed potentiometer (EC motor units)
- Fan coil controller
- Return air sensor
- Valve actuators (Two or four port valves)

Additional optional accessories include: -

- Remote room air sensor
- Remote setpoint adjuster
- Remote fan on/off and speed switches
- Fitted relays for master/slave or BMS control

Dunham-Bush also fit non-standard controls supplied by others; refer to the wiring diagram supplied with the unit.

## CLEANING

Cleaning and maintenance must be carried out by competent persons

### *Inspection*

The frequency of cleaning and inspection depends upon the conditions in which the fan coil unit operates. Initially, it is suggested that the air filter and drip tray are inspected after 6-8 weeks normal operation.

### *Access*

There are four access panels - filter, drip tray/coil, fans/motors and discharge plenum. All access panels can be opened by removing screws and turning quarter-turn fasteners.

The filter can be removed by sliding it out from its mounting on the fan coil inlet, or from below by removing its access panel.

### *Cleaning*

1. Air filters can be cleaned by tapping out excess dust and washing in warm water (up to 40°C), using detergent if necessary. The filter must be rinsed and allowed to dry naturally before replacing. Do not use a vacuum cleaner, as it can damage the filter media. Filters should be replaced after approximately 20 washes.
2. The drip tray can be cleaned with warm, soapy water. Ensure the drip tray drains freely.
3. If a condensate pump is fitted, check any sensors are clean and wiped dry. Test the operation of the pump by pouring clean water into the drip tray.

Because the air filter retains most of the dusty particles, it will only be necessary to clean the fans, motors and coil annually. An industrial vacuum cleaner can be used to clean the inside of the fan coil, in particular the coil and fans, with the air being sucked through the coil in the opposite direction to normal air flow. All accessible surfaces can be cleaned with a cloth.

## MAINTENANCE

1. Purge any air from both cooling and heating sections of the coil using the manual air vents (using a suitable key).
2. The fan motor has 'sealed for life' bearings which do not require any maintenance, other than visual inspection
3. The electrical connections box incorporates a 5A fuse.
4. Each fan coil unit is supplied with a wiring diagram applicable for the particular controls and accessories (Refer to pages 7 and 8). Further copies are available on request. Please quote the serial number on the label on the main access panel.
5. Check the operation of all controls by varying their settings to achieve the desired effect on the fan.

### **▲WARNING**

1. **Prior to undertaking any cleaning or maintenance, ensure that the fan coil unit and any controls are disconnected from the electrical supply at the local isolator.**
2. **Some internal components may have sharp edges. Care must be taken when working on the fan coil unit, and protective gloves should be worn.**



## Declaration of Conformity

We, Dunham-Bush Ltd. of Downley Road, Havant, Hampshire, England, PO9 2JD, hereby declare conformity of the 'Cougar' and 'Cougar EC' Fan Coil Unit product with the following European Union Directives: -

The Electromagnetic Compatibility Directive 2004/108/EC

The Low Voltage Directive 2006/95/EC.

The Energy Related Products Directive 2009/125/EC

In addition, we declare that the 'Cougar' and 'Cougar EC' Fan Coil Unit product complies with the following standards: -

EN 61000-6-3:2007 Electromagnetic Compatibility - generic emission standard

EN 61000-6-1:2007 Electromagnetic Compatibility - generic immunity standard

EN61000-3-2:2006 Electromagnetic Compatibility – Harmonic emissions

EN61000-3-3:2008 Electromagnetic Compatibility – Voltage fluctuations and flicker.

EN 60 335-1:2002 A14:2010 Household and Similar Electrical Appliances. Safety General Requirements

EN 60 335-2-30:2009 Household and Similar Electrical Appliances. Safety Particular Requirements for Room Heaters.

For and on behalf of Dunham-Bush Ltd.

David Shuttleworth B.Sc., C.Eng. MCIBSE.  
Technical Director

Date 11/2/13

**SPARES/SERVICE**

**PLEASE WRITE THE DETAILS OF THE UNIT HERE.**

These details will be required when ordering spares for you Dunham-Bush Cougar Fan Coil Unit

UNIT TYPE AND MODEL INFORMATION

SERIAL NUMBER

DATE OF INSTALLATION

Spare parts/service - Please contact our office, contact information shown below.



**Manufacturer reserves the right to change any product specification without notice.**



Dunham-Bush Ltd, Downley Road, Havant, Hants, PO9 2JD

Sales and Technical Support

Tel: 023 9247 7700 Fax: 023 9245 3601

Email: [info@dunham-bush.co.uk](mailto:info@dunham-bush.co.uk)

Spare Parts and Service

Tel: 023 9247 7700 Fax: 023 9245 3601

Email: [spares@dunham-bush.co.uk](mailto:spares@dunham-bush.co.uk)